

0,5 : 1

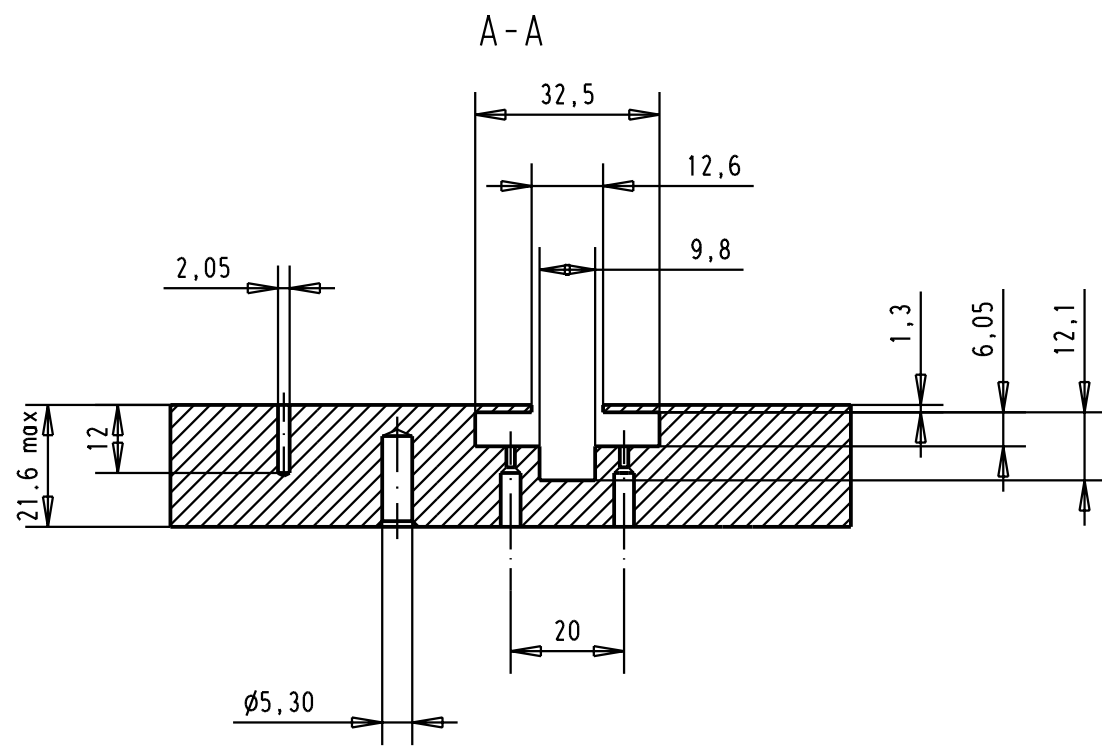

PART 1 : Base plate for D-Sub IDC

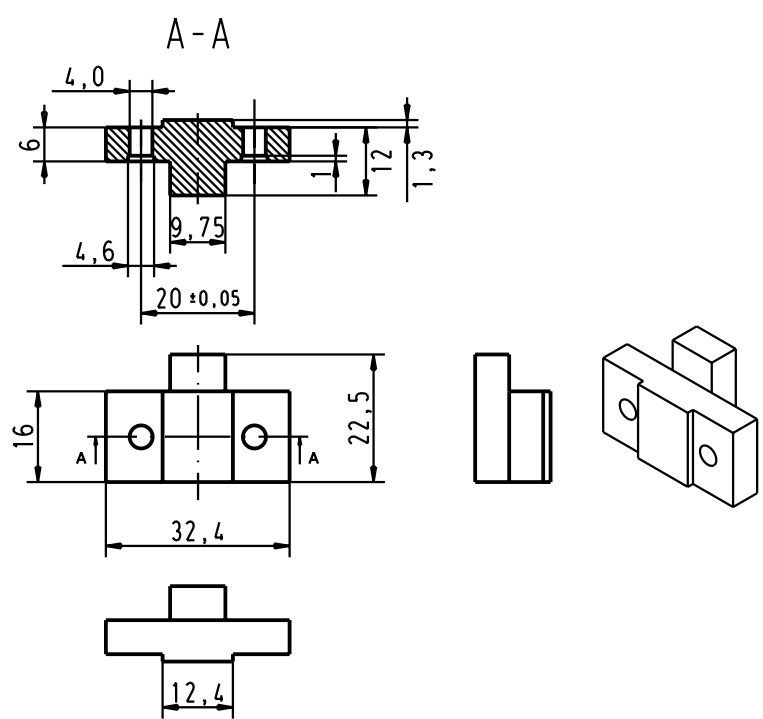
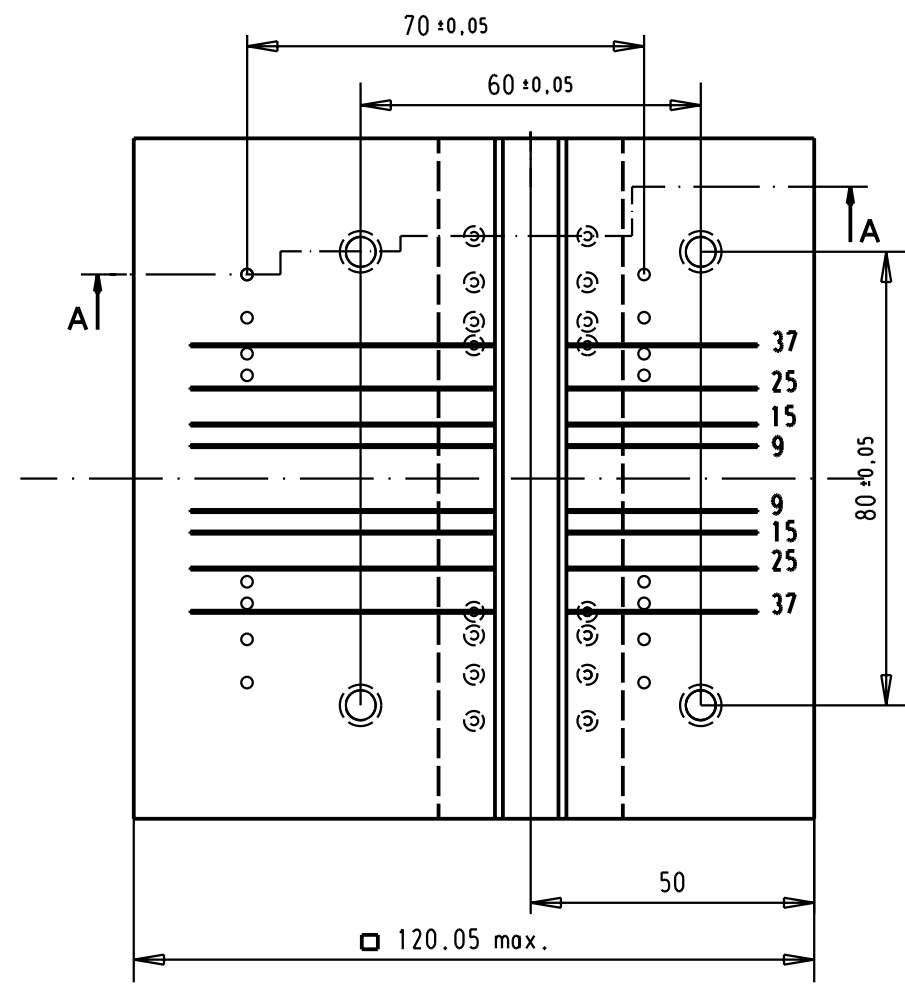

PART 2 : Support for D-Sub IDC

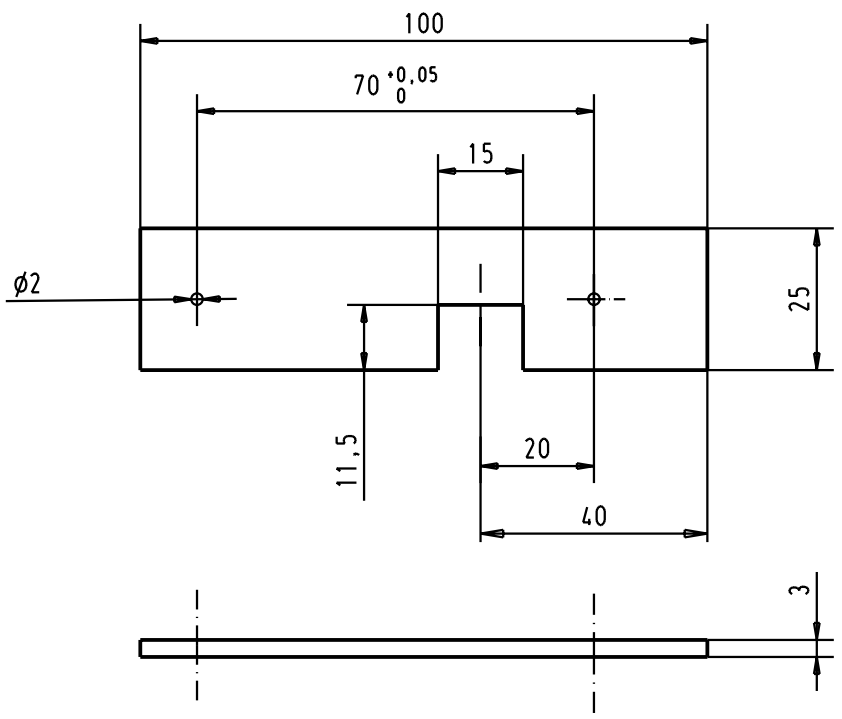

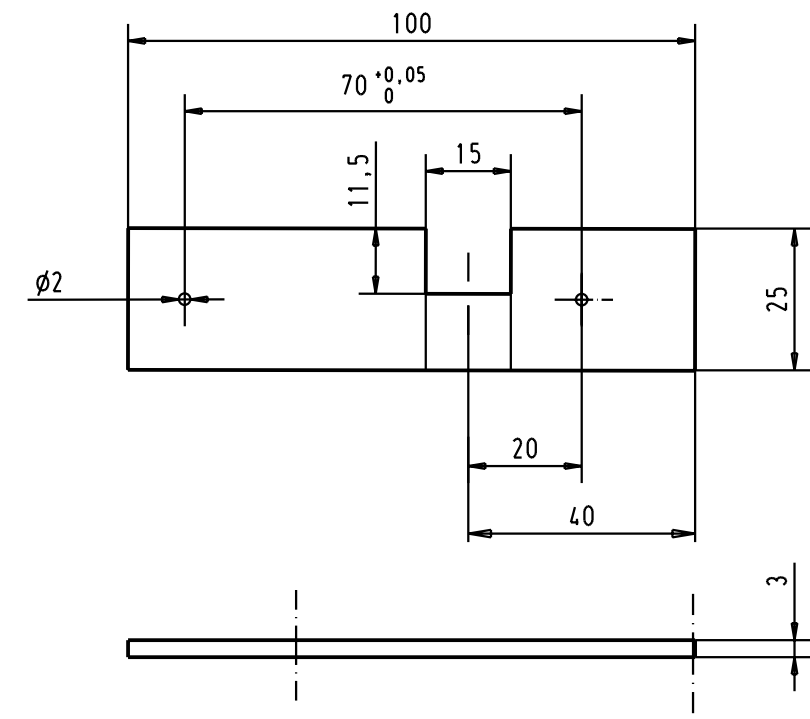

PART 3 : Cable guide (left) for D-Sub

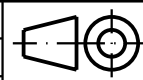

PART 4 : Cable guide (right) for D-Sub

Alle Rechte vorbehalten. All rights reserved.

			Det.	Name	 All Dim. in mm Orig. Size DIN A 3	Tool for D-Sub IDC Maßstab/ Scale 0,75 : 1	
			Detail.	25-APR-02			CV
			Insp.				
			Stand.				
29778	25-APR-02	CV	HARTING EURL F-95972 Paris			Blatt/ Page 1 / 1	
Mod.	Det.	Name					
TB 09990000135							